



Horizon™ Model 704 Guided Wave Radar Level Transmitter

DESCRIPTION

The Horizon Model 704 Transmitter is an intermediately priced 24 VDC, loop-powered, liquid level transmitter based upon Guided Wave Radar (GWR) technology.

The transmitter is designed to provide all of the performance advantages of GWR. Available in a non-rotatable, single compartment plastic or aluminum housing, this transmitter offers simple configuration with three push buttons and a 2-line × 8 character liquid crystal display. The Model 704 covers a broad application range by utilizing coaxial and twin rod probes.

TECHNOLOGY

Horizon Guided Wave Radar is based upon Time Domain Reflectometry (TDR). TDR utilizes pulses of high frequency electromagnetic energy transmitted down a probe. When a pulse reaches a surface that has a higher dielectric than the vapor space in which it is traveling, the pulse is reflected. High-speed timing circuitry precisely measures the total transit time and provides an accurate measure of the liquid level.

APPLICATIONS

MEDIA: Liquids or slurries; hydrocarbons to water-based media (dielectric constants from 1.7 to 100)

VESSELS: Most process or storage vessels up to rated probe temperature and pressure

CONDITIONS: Virtually all level measurement and control applications including those process conditions exhibiting visible vapors, turbulence and varying dielectric media or specific gravity



FEATURES

- Two-wire, 24 VDC, loop-powered transmitter
- HART® communications (optional)
- Varying dielectric constant or specific gravity will have minimal effect on performance
- Probe designs up to +400 °F (+200 °C), 1000 psig (70 bar)
- Available with coaxial and twin rod probes
- No calibration or level movement required
- 16 foot (4.8 meter) measuring range
- Lexan® or Cast aluminum housings
- IS, XP, and Non-Incendive approvals
- 2-line × 8 character LCD and 3-button keypad

TRANSMITTER SPECIFICATIONS

FUNCTIONAL/PHYSICAL

		Model 704
Signal output		4–20 mA (3.8 to 20.5 mA useable)
Span		6 to 192 inches (15 to 488 cm)
Resolution	Analog Display	0.01 mA 0.10 inch or 0.1 cm
Loop resistance		550 Ω @ 24 VDC (20.5 mA)
Damping		0 to 10 seconds
Diagnostic alarm ①		3.6 mA, 22 mA, Hold
User interface		3-button keypad and/or HART communicator (HART communicator Magnetrol P/N 89-5213-XXX sold separately)
Display		2-line x 8-character LCD
Power (at terminals)		12 to 28.6 VDC
Menu language		English
Housing material		Aluminum A356T6 (< 0.2% copper) Lexan, UL94-V0 rating
Net/Gross weight	Aluminum Lexan	3.5 lbs (1.59 kg) 1.5 lbs (.68 kg)
Overall dimensions		H 6.91" (175 mm) x W 3.75" (95 mm)

① 3.6 mA fault output not available with both HART output and LCD.

PERFORMANCE

Use with probes		7XA, 7XB, 7XP & 7XR
Reference conditions		Reflection from water at +70 °F (+20 °C) with 72" (183 mm) probe
Linearity	7XA/7XP/7XR probe 7XB probe	± 0.25 inch (6.3 mm) ± 0.50 inch (12.7 mm)
Resolution		± 0.15 inch (3.8 mm)
Repeatability		0.15 inch (3.8 mm)
Hysteresis		0.15 inch (3.8 mm)
Response time		< 1 second
Warm-up time		< 5 seconds
Operating temperature range	Aluminum housing Plastic housing LCD	-40 to +175 °F (-40 to +80 °C) -40 to +160 °F (-40 to +70 °C) -5 to +160 °F (-20 to +70 °C)
Operating temperature effect		Approximately $\pm 0.03\%$ of probe length / °C
Process dielectric effect		< 0.5 inch (12.7 mm)
Humidity		0–99%, non-condensing
Electromagnetic compatibility		Meets CE requirements (EN 61000-6-2/2001, EN 61000-6-4/2001) (Twin Rod probes must be used in metallic vessel or stillwell to maintain CE compliance)

PROBE OVERVIEW

Choosing the proper Guided Wave Radar (GWR) probe is the most important decision in the application process. The probe configuration establishes fundamental performance characteristics. Coaxial, twin element (rod or cable) and single element (rod or cable) are the three basic configurations used today; each with specific strengths and weaknesses.

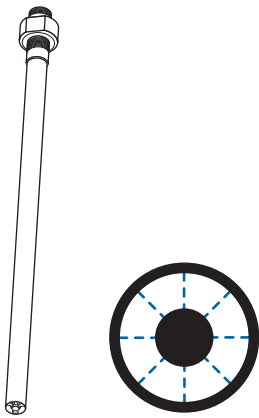

Figure 1
Coaxial Probe

COAXIAL PROBES

The Coaxial probe is the most efficient of all probe configurations and should be the first consideration in all applications. Analogous to the efficiency of modern, coaxial cable, coaxial probes allow almost unimpeded movement of the high frequency pulses throughout its length.

The electromagnetic field that develops between the inner rod and outer tube is completely contained. See Figure 1. The efficiency and sensitivity of a coaxial configuration yields robust signal strength even in extremely low dielectric ($\epsilon_r > 1.7$) applications. The sensitivity of this “closed” design, however, also makes it more susceptible to measurement error in applications of coating and buildup.

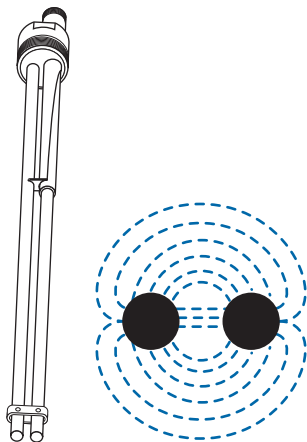

Figure 2
Twin Rod Probe

TWIN ROD PROBES

The relationship of the twin rod probe to a coaxial is similar to that of older, twin-lead, antenna lead-in to modern, coaxial cable. The 300-ohm twin-lead cable simply does not have the efficiency of the 75-ohm coax. The parallel conductor design is less sensitive than the concentric coaxial. See Figure 2. This translates to Twin Rod GWR probes measuring dielectrics of only $\epsilon_r > 2.5$.

The “open” design also allows more accurate measurement where coating/buildup are possible. A film coating has little effect on performance. However, bridging of material between the rods or buildup on the spacers can cause improper measurement and should be avoided. Figure 2 also shows that the electromagnetic field develops not only between the rods, but also expands outward making it more sensitive to proximity effects of objects located in the immediate area.

NOZZLES

The 7XB Twin Rod probe may be susceptible to objects that are in close proximity. The following rules should be followed for proper application:

1. Nozzle should be 3" (80 mm) diameter or larger.
2. For nozzles < 3" (80 mm) diameter, the bottom of the inactive section of the probe should be flush with the bottom of the nozzle or extend into the vessel.

OBSTRUCTIONS (METALLIC)

7XB Twin Rod probes should be installed so the active rod (below the 4" (100 mm) inactive sheath) is > 1" (25 mm) from metallic objects such as pipes, ladders, etc. Bare tank walls parallel to the probe are acceptable.

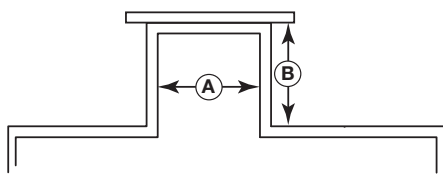

Figure 3

TURBULENCE

The bottom of the probe should be stabilized if turbulence will cause a deflection of more than 3" (80 mm) at 10' (3 m) of length. The probe should not make contact with a metal tank.

COAXIAL PROBE MATRIX



		7XA Standard	7XR Overfill
Recommended for		General purpose; clean low viscosity liquids < 300 °F (150 °C)	Overfill, temps +300 to +400 °F (+150 to +200 °C); clean, low viscosity liquids
Not recommended for		Coating and buildup, foam	
Materials/Wetted parts		316L SS, TFE, Viton® GFLT	
	Optional	Hastelloy® C, Monel	
Process seal		Viton® GFLT O-ring ①	
Spacers		TFE	
Diameter		∅ .3125" (8 mm) rod ∅ .875" (22 mm) tube	
Process connection thread		¾" NPT, 1" BSP	
Flange ANSI (DIN)		1" to 4" (DN25 to 100)	
Length		24 to 192 inches (60 to 488 cm)	
Transition zone ②	Top	1" (25 mm) @ $\epsilon_r = 1.7$ 6" (150 mm) @ $\epsilon_r = 80$	None
	Bottom	6" (150 mm) @ $\epsilon_r = 1.7$ 1" (25 mm) @ $\epsilon_r = 80$	
Process temperature ③	Maximum	+300 °F @ 400 psig (+150 °C @ 27 bar)	+400 °F @ 270 psig (+200 °C @ 18 bar)
	Minimum/cryogenic	-40 °F @ 750 psig (-40 °C @ 50 bar)	
Process pressure	Maximum	1000 psig @ 70 °F (70 bar @ 20 °C)	
	Minimum/vacuum service	Yes, not hermetic	
Dielectric range		≥ 1.7	
Maximum viscosity (cP)		500	
Mounting effects		None	
Coating/Buildup		No	
Foam		No	
Corrosives		Yes	
Hygienic		No	
Overfill		No	
Approvals	FM CSA ATEX OTHER	Yes Yes Yes No	

① Refer to Selection Chart on page 7 for optional O-rings.

② Transition Zone is dielectric dependent: ϵ_r = dielectric permittivity. Unit will function but accuracy will decrease in Transition Zone.

③ Refer to Ambient Temperature vs. Process Temperature graph on page 8.

COAXIAL PROBE MATRIX



		7XP High Pressure
Recommended for		Clean, high pressure liquids < +400 °F (+200 °C)
Not recommended for		Coating and buildup, foam, steam
Materials/Wetted parts		316L SS, TFE, Borosilicate, Inconel X750
	Optional	Hastelloy C, Monel
Process seal		Borosilicate
Spacers		TFE
Diameter	Standard	∅ .3125" (8 mm) rod ∅ .875" (22 mm) tube
	Enlarged	∅ .63" (15 mm) rod ∅ 1.75" (45 mm) tube
Process connection thread	Standard	¾" NPT, 1" BSP
	Enlarged	2" NPT
Flange ANSI (DIN)	Standard	1 to 4" (DN25 to 100)
	Enlarged	2 to 4" (DN25 to 100)
Length		24 to 192" (60 to 488 cm)
Transition zone ②	Top	1" (25 mm) @ $\epsilon_r = 1.4$ 6" (150 mm) @ $\epsilon_r = 80$
	Bottom	6" (150 mm) @ $\epsilon_r = 1.4$ 1" (25 mm) @ $\epsilon_r = 80$
Process temperature ③	Maximum	+400 °F @ 5500 psig (+200 °C @ 379 bar)
	Minimum/cryogenic	-320 °F @ 6250 psig (-195 °C @ 430 bar)
Process pressure	maximum	6250 psig @ +70 °F (431 bar @ +20 °C)
	Minimum/vacuum service	Yes, not hermetic (< 10 ⁻⁸ cc/sec @ 1 atmos.)
Dielectric range		1.7 to 100
Maximum viscosity (cP)	Standard	500
	Enlarged	1500
Mounting effects		None
Coating/Buildup		No
Foam		No
Corrosives		Yes
Hygienic		No
Overfill		No
Approvals	FM CSA ATEX OTHER	Yes Yes Yes No

TWIN ROD PROBE



		7XB Twin Rod-Rigid
Recommended for		General purpose, foam, minor film coating
Not recommended for		Media bridging between rods or building up on spacers
Materials/Wetted parts		316L stainless steel, TFE, Viton® GFLT
	Optional	Hastelloy C, Monel
Process seal		Viton® GFLT O-ring ①
Spacers		TFE
Diameter		Two, \varnothing .50" (13 mm) rod; .875" (22 mm) C_L to C_L
Process connection thread		2" NPT, 2" BSP
Flange ANSI (DIN)		2" to 4" (DN50 to 100)
Length		24 to 192 inches (60 to 488 cm)
Transition zone ②	Top	1" (25 mm) @ $\epsilon_r > 10$, 8" (200 mm) @ $\epsilon_r < 10$ (+4" (100 mm) inactive)
	Bottom	6" (150 mm) @ $\epsilon_r = 2.5$ 1" (25 mm) @ $\epsilon_r = 80$
Deadband	Top	4" (+4" inactive section)
Process temperature ③	Maximum	+400 °F @ 200 psig (+200 °C @ 13 bar)
	Minimum/cryogenic	-40 °F @ 750 psig (-40 °C @ 50 bar)
Process pressure	Maximum	750 psig @ +70° F (50 bar @ +20 °C)
	Minimum/vacuum service	Yes, not hermetic
Dielectric range		≥ 2.5
Maximum viscosity (cP)		1500
Mounting effects ④		Active rod > 1" from any obstruction
Coating/Buildup ⑤		Film: 3% max. error of coated length with conductive media Bridging not recommended
Foam		Yes
Corrosives		Yes
Hygienic		No
Overfill		No
Approvals	FM	Yes
	CSA	Yes
	ATEX	Yes
	OTHER	No

① Refer to Selection Chart on page 7 for optional O-rings.

② Transition Zone is dielectric dependent: ϵ_r = dielectric permittivity.

Unit will function but accuracy will decrease in Transition Zone.



NOTE: Output may go to Fault mode when medium is within top 7 inches of probe and $\epsilon_r < 20$.

③ Refer to Ambient Temperature vs. Process Temperature graph on page 8.

④ Minimum stillwell diameter for Twin Rod probe is 3 inch (80 mm).

⑤ Bridging is defined as continuous accumulation of material between the probe elements.

AGENCY APPROVALS

AGENCY	MODEL	PROTECTION METHOD	AREA CLASSIFICATION
FM  APPROVED	704-5XXX-14X	Intrinsically Safe	Class I, Div. 1; Groups A, B, C, & D Class II, Div. 1; Groups E, F, & G Class III, IP67 Entity
	704-5XXX-54X	Explosion Proof	Class I, Div. 1; Groups B, C & D Class II, Div. 1; Groups F, & G Class III; Type 4X; IP67
	704-5XXX-14X 704-5XXX-54X	Non-Incendive, suitable for: ①	Class I, Div. 2; Groups A, B, C, & D Class II, Div. 2; Groups F & G Class III; Type 4X; IP67
CSA 	704-5XXX-14X	Intrinsically Safe	Class I, Div. 1; Groups A, B, C, & D Class II, Div. 1; Group G Class III, Type 4X; IP66/67 Entity
	704-5XXX-54X	Explosion Proof	Class I, Div. 1; Groups C & D Class II, Div. 1; Groups G Class III, Type 4X; IP 66/67
	704-5XXX-14X 704-5XXX-54X	Non-Incendive, suitable for: ①	Class I, Div. 2; Groups A, B, C, & D Class II, Div. 2; Group G Class III, Type 4X; IP66/67
ATEX 	704-5XXX-A4X	Intrinsically Safe	Ⓜ II 1G, EEx ia IIC T4

① Measured media inside vessel must be non-flammable only.



These units are in conformity of:

1. The EMC Directive: 89/336/EEC. The units have been tested to EN 61000-6-2/2001 and EN 61000-6-4/2001.
2. Directive 94/9/EC for equipment or protective system for use in potentially explosive atmospheres (8th digit "A" only).

O - R I N G (S E A L) S E L E C T I O N C H A R T

Material	Code	Maximum Temperature ^①	Min. Temp.	Recommended For Use In	Not Recommended For Use In
Viton® GFLT	0	+400 °F (+200 °C)	-40 °F (-40 °C)	General purpose, steam, ethylene	Ketones (MEK, acetone), skydrol fluids, amines, anhydrous ammonia, low molecular weight esters and ethers, hot hydrofluoric or chlorosulfuric acids, sour HCs
EPDM	1	+250 °F (+125 °C)	-60 °F (-50 °C)	Acetone, MEK, skydrol fluids	Petroleum oils, di-ester base lubricants, propane, steam, anhydrous ammonia
Kalrez® (4079)	2	+400 °F (+200 °C)	-40 °F (-40 °C)	Inorganic and organic acids (including HF and nitric) aldehydes, ethylene, glycols, organic oils, silicone oils, vinegar, sour HCs	Black liquor, hot water/steam, hot aliphatic amines, ethylene oxide, propylene oxide, molten sodium, molten potassium, anhydrous ammonia
Aegis PF128	8	+400 °F (+200 °C)	-4 °F (-20 °C)	Inorganic and organic acids (including HF and nitric) aldehydes, ethylene, glycols, organic oils, silicone oils, vinegar, sour HCs, steam, amines, ethylene oxide, propylene oxide	Black liquor, Freon 43, Freon 75, Galden, KEL-F liquid, molten sodium, molten potassium, anhydrous ammonia
Borosilicate	N	+800 °F (+430 °C)	-320 °F (-195 °C)	General high temperature/high pressure applications, hydrocarbons, full vacuum (hermetic), ammonia	Steam, hot alkaline solutions HF acid, media with ph>12

DIMENSIONAL SPECIFICATIONS

INCHES (MM)

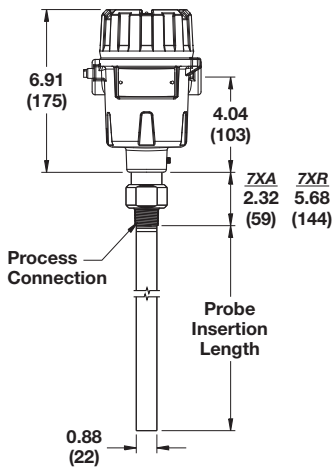

Model 7XA/7XR Probe
NPT Threaded Connection

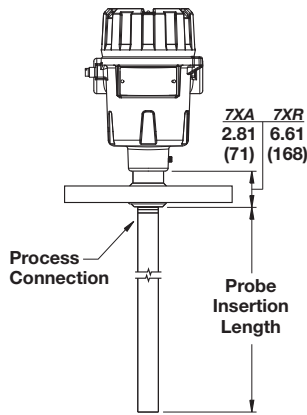

Model 7XA/7XR Probe
Flanged Connection

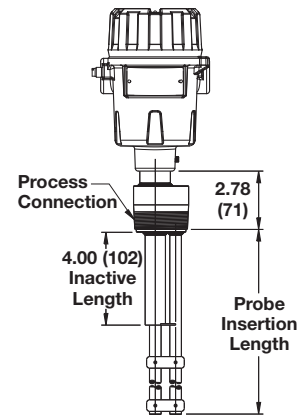

Model 7XB Twin Rod Probe
NPT Threaded Connection

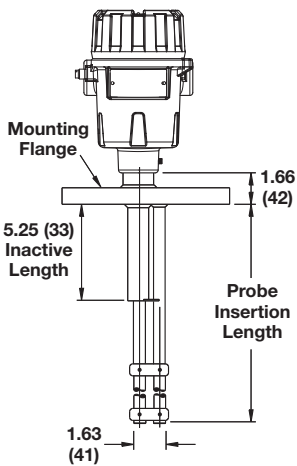

Model 7XB Twin Rod Probe
Flanged Connection

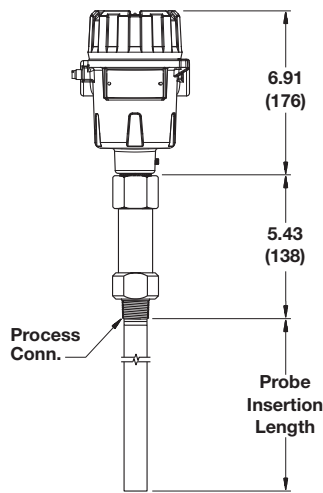

Model 7XP Probe
Threaded Connection

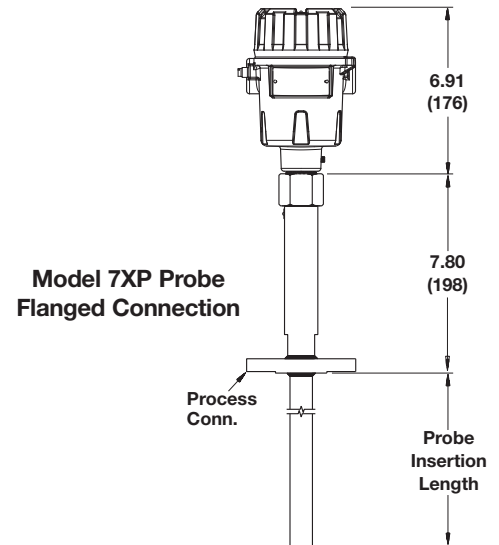

Model 7XP Probe
Flanged Connection

TEMPERATURE / PRESSURE CHARTS

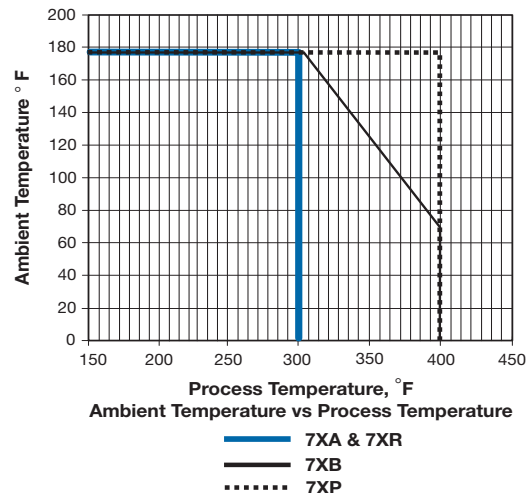
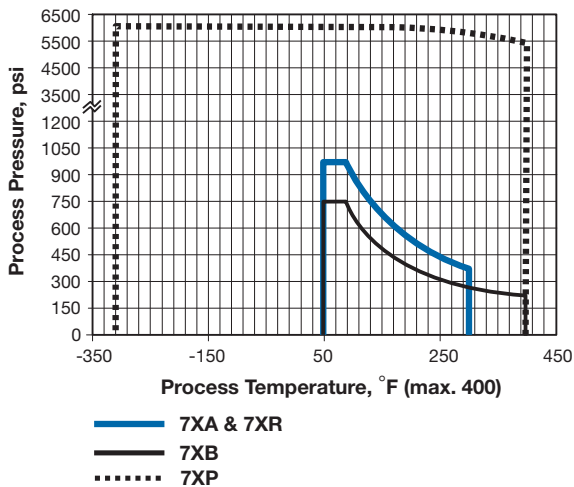

TRANSMITTER

MODEL NUMBER

BASIC MODEL NUMBER

704	Horizon Guided Wave Radar Level Transmitter for use with probe models 7XA, 7XB, 7XF, 7XR and 7X1 only
-----	---

POWER

5	24 VDC, Two-wire
---	------------------

SIGNAL OUTPUT

1	4–20 mA with HART (HART communicator Magnetrol P/N 89-5213-XXX sold separately)
---	---

MENU LANGUAGE

1	English
---	---------

ACCESSORIES

A	Digital display and keypad
---	----------------------------

MOUNTING/CLASSIFICATION

1	Integral, General Purpose & Intrinsically Safe (FM & CSA), Non-Incendive (Class I, Div. 2)
5	Integral, Explosion Proof (FM & CSA) (must be ordered with Housing Code 4)
A	Integral, General Purpose & Intrinsically Safe (ATEX EEx ia IIC T4)

HOUSING

3	Lexan, single compartment
4	Cast aluminum, single compartment

CONDUIT CONNECTION

0	¾" NPT
1	M20

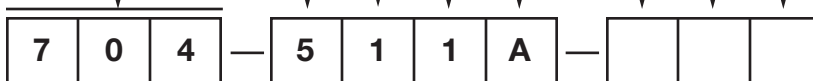

PROBE

MODEL NUMBER

BASIC MODEL NUMBER

7E	Horizon GWR probe, English unit of measure
7M	Horizon GWR probe, Metric unit of measure

CONFIGURATION/STYLE

A	Coaxial, 3/4" process connection or larger	(Dielectric range ≥ 1.7)
B	Twin Rod, 2" NPT or 3" flanged process connection or larger	(Dielectric range ≥ 2.5)
P	Coaxial, High Pressure	(Dielectric range ≥ 1.7)
R	Coaxial, Overfill 3/4" process connection or larger	(Dielectric range ≥ 1.7)

MATERIAL OF CONSTRUCTION

A	316/316L stainless steel
B	Hastelloy C
C	Monel

PROCESS CONNECTION SIZE/TYPE

Refer to next page for selections

O-RINGS

0	Viton® GFLT
1	EPDM (Ethylene Propylene Rubber)
2	Kalrez 4079
8	Aegis PF128
N	None (Use with Model 7XP)

LENGTH – PROBE MODELS 7XA, 7XB, 7XP & 7XR

24 to 192 inches (60 to 488 cm)
 (unit of measure is determined by second digit of Model Number)
 Examples: 24 inches = 024; 60 centimeters = 060

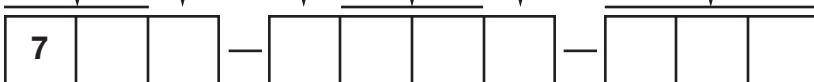

MODEL NUMBER

PROCESS CONNECTION SIZE/TYPE
THREADED CONNECTIONS

11	3/4" NPT Thread ①
22	1" BSP Thread ①
41	2" NPT Thread ②
42	2" BSP Thread ②

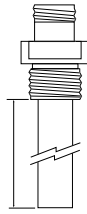

Insertion Length
NPT Process
Connection

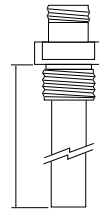

Insertion Length
BSP Process
Connection

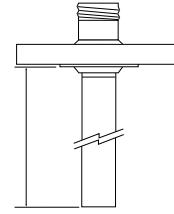

Insertion Length
ANSI or DIN
Welded Flange

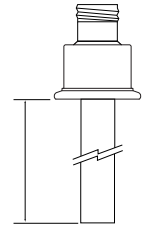

Insertion Length
Hygienic Flange

ANSI RAISED FACE FLANGE CONNECTIONS

23	1" 150#	ANSI Raised Face Flange ①
24	1" 300#	ANSI Raised Face Flange ①
25	1" 600#	ANSI Raised Face Flange ①
33	1 1/2" 150#	ANSI Raised Face Flange ①
34	1 1/2" 300#	ANSI Raised Face Flange ①
35	1 1/2" 600#	ANSI Raised Face Flange ①
43	2" 150#	ANSI Raised Face Flange ①
44	2" 300#	ANSI Raised Face Flange ①

45	2" 600#	ANSI Raised Face Flange ①
53	3" 150#	ANSI Raised Face Flange
54	3" 300#	ANSI Raised Face Flange
55	3" 600#	ANSI Raised Face Flange ①
63	4" 150#	ANSI Raised Face Flange
64	4" 300#	ANSI Raised Face Flange
65	4" 600#	ANSI Raised Face Flange ①

ANSI RING JOINT FLANGE CONNECTIONS

3K	1 1/2" 600#	ANSI Ring Joint Flange ①
4K	2" 600#	ANSI Ring Joint Flange ①
5K	3" 600#	ANSI Ring Joint Flange ①
6K	4" 600#	ANSI Ring Joint Flange ①

DIN FLANGE CONNECTIONS

BA	DN 25, PN 16	DIN 2527 Form B Flange ①
BB	DN 25, PN 25/40	DIN 2527 Form B Flange ①
BC	DN 25, PN 64/100	DIN 2527 Form E Flange ①
CA	DN 40, PN 16	DIN 2527 Form B Flange ①
CB	DN 40, PN 25/40	DIN 2527 Form B Flange ①
CC	DN 40, PN 64/100	DIN 2527 Form E Flange ①
DA	DN 50, PN 16	DIN 2527 Form B Flange
DB	DN 50, PN 25/40	DIN 2527 Form B Flange
DD	DN 50, PN 64	DIN 2527 Form E Flange ①

DE	DN 50, PN 100	DIN 2527 Form E Flange ①
EA	DN 80, PN 16	DIN 2527 Form B Flange
EB	DN 80, PN 25/40	DIN 2527 Form B Flange
ED	DN 80, PN 64	DIN 2527 Form E Flange ①
EE	DN 80, PN 100	DIN 2527 Form E Flange ①
FA	DN 100, PN 16	DIN 2527 Form B Flange
FB	DN 100, PN 25/40	DIN 2527 Form B Flange
FD	DN 100, PN 64	DIN 2527 Form E Flange ①
FE	DN 100, PN 100	DIN 2527 Form E Flange ①

- ① Configuration/Style Codes A only.
- ② Configuration/Style Codes B only.



QUALITY



The quality assurance system in place at Magnetrol guarantees the highest level of quality throughout the company. Magnetrol is committed to providing full customer satisfaction both in quality products and quality service.

The Magnetrol quality assurance system is registered to ISO 9001 affirming its commitment to known international quality standards providing the strongest assurance of product/service quality available.

ESP

Expedite **S**hip **P**lan

Several Models of Horizon Guided Wave Radar Transmitters are available for quick shipment, usually within one week after factory receipt of a purchase order, through the Expedite Ship Plan (ESP).

Models covered by ESP service are color coded in the selection data charts.

To take advantage of ESP, simply match the color coded model number codes (standard dimensions apply).

ESP service may not apply to orders of ten units or more. Contact your local representative for lead times on larger volume orders, as well as other products and options.

WARRANTY



All Magnetrol electronic level and flow controls are warranted free of defects in materials or workmanship for eighteen months from the date of original factory shipment.

If returned within the warranty period; and, upon factory inspection of the control, the cause of the claim is determined to be covered under the warranty; then, Magnetrol will repair or replace the control at no cost

to the purchaser (or owner) other than transportation.

Magnetrol shall not be liable for misapplication, labor claims, direct or consequential damage or expense arising from the installation or use of equipment. There are no other warranties expressed or implied, except special written warranties covering some Magnetrol products.

For additional information, see Instruction Manual 57-603.



705 Enterprise Street • Aurora, Illinois 60504-8149 • 630.969.4000
info@magnetrol.com • magnetrol.com

Copyright © 2019 Magnetrol International, Incorporated.
Performance specifications are effective with date of issue and are subject to change without notice.

Hastelloy is a registered trademark of Haynes International, Inc.
Lexan is a registered trademark of General Electric
Viton® is a registered trademark of DuPont Performance Elastomers.

BULLETIN: 57-104.6
EFFECTIVE: May 2019
SUPERSEDES: June 2014